

LEDTOUCH™ Downlight Datasheet



LEDTOUCH™ Downlight series is the superior general lighting solution for shopping malls, office buildings and public spaces. Leading-edge optics provides high lumen output and low glare which result in excellent lighting performance. LEDTOUCH™ Downlight series offers a wide range of sizes, powers and beam angles for creating the perfect space hierarchy, space atmosphere and sense of well-being.

Benefits

Total solution and flexibility

- 5 sizes, 6 power consumption levels and 3 beam angles (narrow/middle/wide) for various application scenarios
- Optional screw and clipper mounting
- DALI on request

Outstanding light performance

- No ghost shadow with COB technology
- Fresnel and micro lenses designed to ensure evenly distributed light
- Low glare, UGR<19
- Flicker free from camera

Robust and safety

- 50,000hrs lifetime from best-in-class COB and driver
- All die-cast housing
- Safety cable for reflector
- Safety cable hole reserved

Applications

- Shopping malls
- Office buildings
- Retail stores
- Airports
- Metro stations
- Public buildings

LEDTOUCH™ Downlight

Technical Data

Optical Specifications

		3"	4"	5"		6"		8"		
Luminous Flux	2700K	950 lm	950 lm	1250 lm	1900 lm	1900 lm	2700 lm	3800 lm	3800 lm	5100 lm
	3000K	950 lm	950 lm	1250 lm	1900 lm	1900 lm	2700 lm	3800 lm	3800 lm	5100 lm
	4000K	1000 lm	1000 lm	1350 lm	2000 lm	2000 lm	2800 lm	4000 lm	4000 lm	5400 lm
Efficacy		85 lm/W	85 lm/W	85 lm/W	100 lm/W	100 lm/W	100 lm/W	95 lm/W	95 lm/W	85 lm/W
CCT		2700K, 3000K, 4000K			*5700K					
CRI		≥80								
SDCM		3								
UGR		<19								
Beam Angle		26°	28°	28°	26°	26°	28°	28°	28°	28°
		38°	40°	40°	38°	38°	40°	40°	38°	38°
			*50°	*50°	46°	46°	50°	50°	55°	55°

Electrical and Mechanical Specifications

Input Voltage	220-240V AC 50/60Hz									
Power Consumption	11W	11W	15W	20W	20W	28W	40W	40W	40W	*60W
Power Factor	≥0.9									
Total Harmonic Distortion	<10%									<15%
Dimensions	Diameter	85mm	110mm	110mm	135mm	160mm	160mm	160mm	210mm	210mm
	Height	110mm	115mm	115mm	160mm	160mm	160mm	160mm	200mm	200mm
Weight	0.54kg	0.71kg	0.71kg	1.15kg	1.45kg	1.45kg	1.45kg	1.45kg	2.71kg	2.71kg
Cover Lens	PC fresnel lens + glass									
Housing	Die-casting heatsink RAL7035 + Die-casting mounting ring RAL9003									

System Specifications

Power	AC line									
Dimmable	ON/OFF, *DALI on request									
Mounting Hole	75mm	100mm	100mm	125mm	150mm	150mm	150mm	200mm	200mm	200mm
Installation Height	140mm	145mm	145mm	190mm	230mm	230mm	230mm	230mm	230mm	230mm
Operating Temperature	-15°C to +40°C									
Storage Temperature	-35°C to +80°C									
Environment	Indoor (IP20)									
Lumen Maintenance	L70 @25°C - 50,000hrs									30,000 hrs
Safety Approval	Electrical Protection Class II, CB, CE, CCC									

Items with * are non-standard items and are available on request. Specification is subject to change due to continuous improvement.

Due to the special conditions of manufacturing process of LED, the typical data of technical parameters can only reflect statistical figures and do not necessarily correspond to the actual parameters of each single product which could differ from typical data.

Exceeding maximum ratings for operation voltage will cause hazardous overload and will likely destroy the LED module.

Exceeding maximum ratings for operation and storage temperature will reduce expected life time or destroy the LED module.

08/16 V1.0 · Specifications are subject to change without notice. Errors and omission excepted, always make sure to use the most recent release.

©2016 OSRAM GmbH · All rights reserved · Internet www.lightingsolutions.osram.com/asia

2 of 9

LEDTOUCH™ Downlight

Dimensions

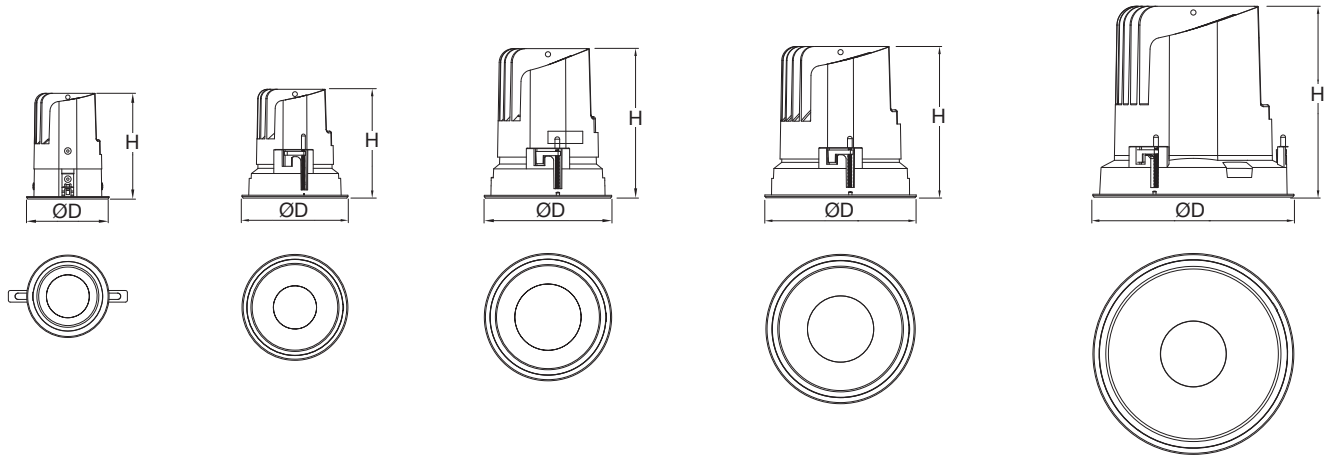

Dimensions

	3"	4"	5"	6"	8"
ØD	85mm	110mm	135mm	160mm	210mm
H	110mm	115mm	160mm	160mm	200mm

Photometrics Light Distribution Curve

3", 11W, 26°

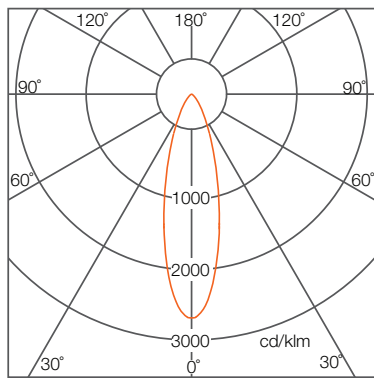

3", 11W, 38°

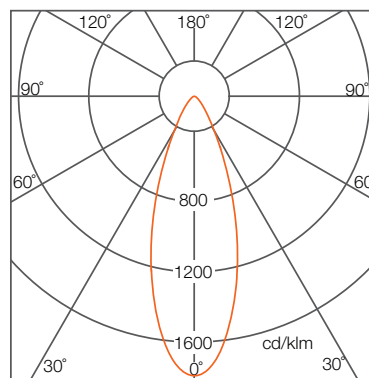

Illuminance at a distance

	Center Beam Lux/klm	Beam Width
0.5m	10983	0.25m
1m	2746	0.5m
1.5m	1220	0.75m
2m	686	1m
2.5m	439	1.26m
3m	305	1.51m

For feet multiply by 3.28

● Spread: 28.2°
For fc divide by 10.7

	Center Beam Lux/klm	Beam Width
0.5m	7118	0.37m
1m	1779	0.73m
1.5m	791	1.10m
2m	445	1.46m
2.5m	285	1.83m
3m	198	2.20m

For feet multiply by 3.28

● Spread: 40.2°
For fc divide by 10.7

Due to the manufacturing processes of LED, the polar candela distribution and distance luminaries only reflect statistical figures and do not necessarily correspond to the actual parameters of individual product that may differ from the typical values.

08/16 V1.0 · Specifications are subject to change without notice. Errors and omission excepted, always make sure to use the most recent release.

©2016 OSRAM GmbH · All rights reserved · Internet www.lightingsolutions.osram.com/asia

LEDTOUCH™ Downlight

Photometrics

Light Distribution Curve

4", 11W/15W, 28°

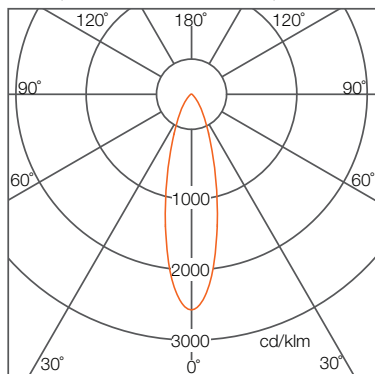

4", 11W/15W, 40°

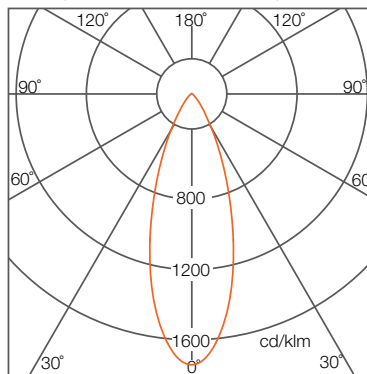

Illuminance at a distance

	Center Beam Lux/klm	Beam Width
0.5m	10582	0.26m
1m	2645	0.51m
1.5m	1176	0.77m
2m	661	1.03m
2.5m	423	1.28m
3m	294	1.54m

For feet multiply by 3.28

● Spread: 28.8°
For fc divide by 10.7

	Center Beam Lux/klm	Beam Width
0.5m	6817	0.38m
1m	1704	0.76m
1.5m	757	1.14m
2m	426	1.52m
2.5m	273	1.90m
3m	189	2.28m

For feet multiply by 3.28

● Spread: 41.6°
For fc divide by 10.7

Light Distribution Curve

5", 20W, 26°

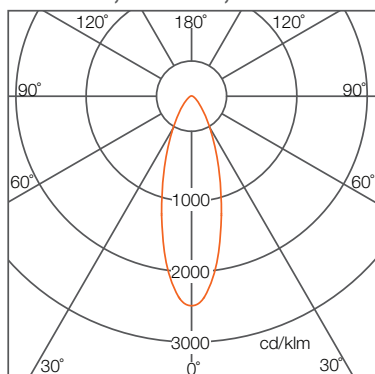

5", 20W, 38°

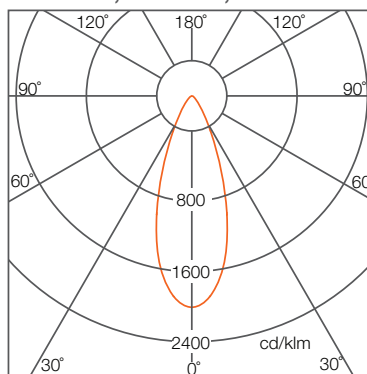

Illuminance at a distance

	Center Beam Lux/klm	Beam Width
0.5m	9738	0.27m
1m	2435	0.54m
1.5m	1082	0.80m
2m	609	1.07m
2.5m	390	1.34m
3m	271	1.61m

For feet multiply by 3.28

● Spread: 30°
For fc divide by 10.7

	Center Beam Lux/klm	Beam Width
0.5m	7919	0.35m
1m	1980	0.70m
1.5m	880	1.05m
2m	495	1.40m
2.5m	317	1.75m
3m	220	2.10m

For feet multiply by 3.28

● Spread: 38.6°
For fc divide by 10.7

Due to the manufacturing processes of LED, the polar candela distribution and distance luminaries only reflect statistical figures and do not necessarily correspond to the actual parameters of individual product that may differ from the typical values.

08/16 V1.0 · Specifications are subject to change without notice. Errors and omission excepted, always make sure to use the most recent release.

©2016 OSRAM GmbH · All rights reserved · Internet www.lightingsolutions.osram.com/asia

LEDTOUCH™ Downlight

Photometrics

Light Distribution Curve

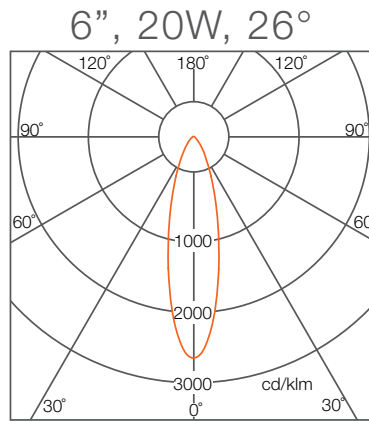
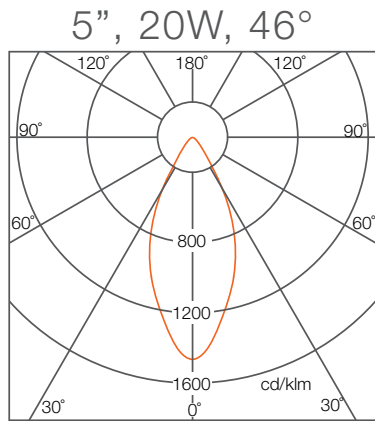

Illuminance at a distance

Distance (m)	Center Beam Lux/klm	Beam Width (m)
0.5m	5837	0.45m
1m	1459	0.91m
1.5m	649	1.36m
2m	365	1.81m
2.5m	233	2.27m
3m	162	2.72m

For feet multiply by 3.28

● Spread: 48.8°
For fc divide by 10.7

Distance (m)	Center Beam Lux/klm	Beam Width (m)
0.5m	10790	0.25m
1m	2698	0.50m
1.5m	1199	0.75m
2m	674	1.00m
2.5m	432	1.25m
3m	300	1.50m

For feet multiply by 3.28

● Spread: 28°
For fc divide by 10.7

Light Distribution Curve

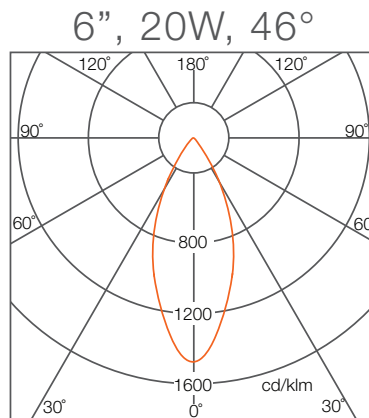
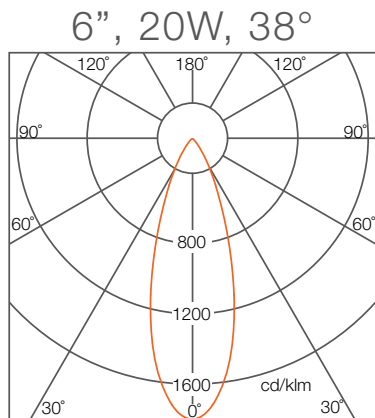

Illuminance at a distance

Distance (m)	Center Beam Lux/klm	Beam Width (m)
0.5m	7936	0.35m
1m	1984	0.69m
1.5m	882	1.04m
2m	496	1.39m
2.5m	317	1.73m
3m	220	2.08m

For feet multiply by 3.28

● Spread: 38.2°
For fc divide by 10.7

Distance (m)	Center Beam Lux/klm	Beam Width (m)
0.5m	5994	0.44m
1m	1498	0.88m
1.5m	666	1.32m
2m	375	1.76m
2.5m	240	2.19m
3m	166	2.63m

For feet multiply by 3.28

● Spread: 47.4°
For fc divide by 10.7

Due to the manufacturing processes of LED, the polar candela distribution and distance luminaries only reflect statistical figures and do not necessarily correspond to the actual parameters of individual product that may differ from the typical values.

08/16 V1.0 · Specifications are subject to change without notice. Errors and omission excepted, always make sure to use the most recent release.

©2016 OSRAM GmbH · All rights reserved · Internet www.lightingsolutions.osram.com/asia

LEDTOUCH™ Downlight

Photometrics

Light Distribution Curve

6", 28W/40W, 28°

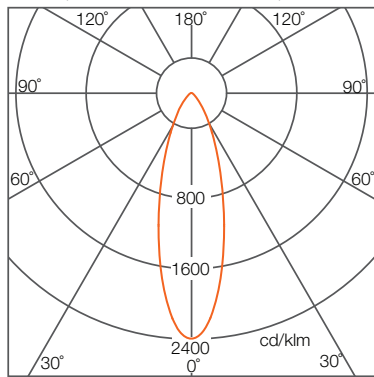

6", 28W/40W, 40°

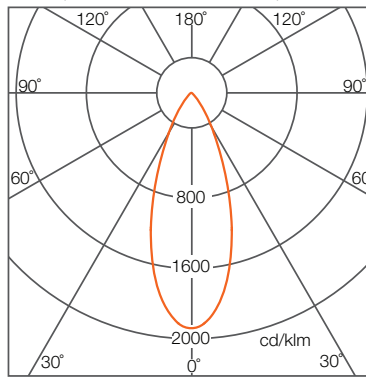

Illuminance at a distance

	Center Beam Lux/klm	Beam Width
0.5m	9564	0.28m
1m	2391	0.55m
1.5m	1063	0.83m
2m	598	1.11m
2.5m	383	1.39m
3m	266	1.66m

For feet multiply by 3.28

● Spread: 31°
For fc divide by 10.7

	Center Beam Lux/klm	Beam Width
0.5m	7679	0.36m
1m	1920	0.72m
1.5m	853	1.07m
2m	480	1.43m
2.5m	307	1.79m
3m	213	2.15m

For feet multiply by 3.28

● Spread: 39.4°
For fc divide by 10.7

Light Distribution Curve

6", 28W/40W, 50°

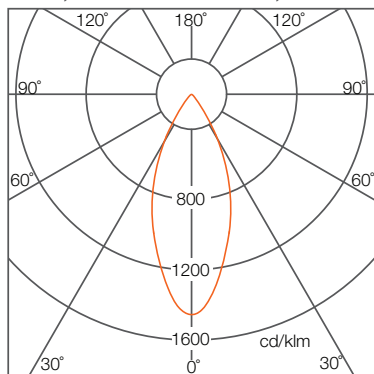

8", 40W/60W, 28°

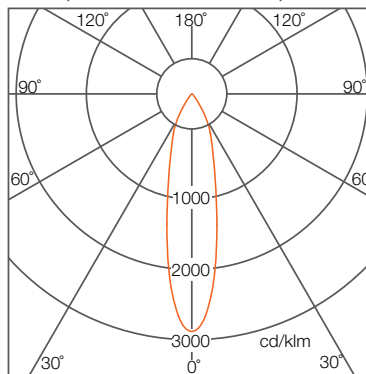

Illuminance at a distance

	Center Beam Lux/klm	Beam Width
0.5m	5871	0.44m
1m	1468	0.89m
1.5m	652	1.33m
2m	367	1.77m
2.5m	235	2.22m
3m	163	2.66m

For feet multiply by 3.28

● Spread: 47.8°
For fc divide by 10.7

	Center Beam Lux/klm	Beam Width
0.5m	11710	0.23m
1m	2927	0.47m
1.5m	1301	0.70m
2m	732	0.93m
2.5m	468	1.16m
3m	325	1.40m

For feet multiply by 3.28

● Spread: 26.2°
For fc divide by 10.7

Due to the manufacturing processes of LED, the polar candela distribution and distance luminaries only reflect statistical figures and do not necessarily correspond to the actual parameters of individual product that may differ from the typical values.

08/16 V1.0 · Specifications are subject to change without notice. Errors and omission excepted, always make sure to use the most recent release.

©2016 OSRAM GmbH · All rights reserved · Internet www.lightingsolutions.osram.com/asia

LEDTOUCH™ Downlight

Photometrics

Light Distribution Curve

8", 40W/60W, 38°

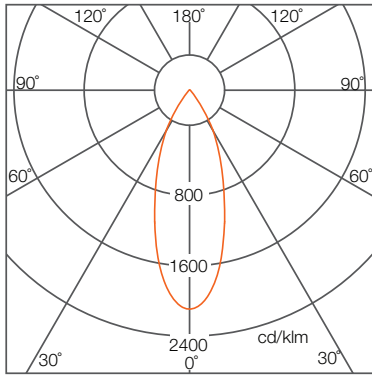

8", 40W/60W, 55°

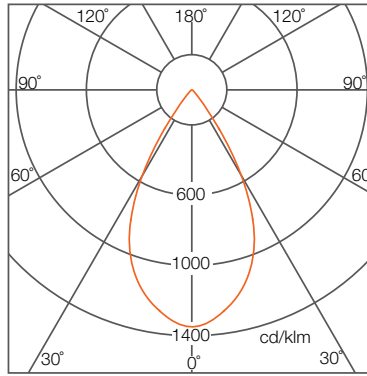

Illuminance at a distance

	Center Beam Lux/klm	Beam Width
0.5m	8534	0.33m
1m	2133	0.66m
1.5m	948	0.99m
2m	533	1.32m
2.5m	341	1.64m
3m	237	1.97m

For feet multiply by 3.28

● Spread: 36.4°
For fc divide by 10.7

	Center Beam Lux/klm	Beam Width
0.5m	5367	0.53m
1m	1342	1.06m
1.5m	596	1.59m
2m	335	2.12m
2.5m	215	2.65m
3m	149	3.18m

For feet multiply by 3.28

● Spread: 55.8°
For fc divide by 10.7

Due to the manufacturing processes of LED, the polar candela distribution and distance luminaries only reflect statistical figures and do not necessarily correspond to the actual parameters of individual product that may differ from the typical values.

08/16 V1.0 · Specifications are subject to change without notice. Errors and omission excepted, always make sure to use the most recent release.

©2016 OSRAM GmbH · All rights reserved · Internet www.lightingsolutions.osram.com/asia

LEDTOUCH™ Downlight

Ordering Codes

Fixture

Short Text	Diameter	Power	Beam Angle	CCT	EAN10	EAN40
LDTH DL 311 L26 827 9X1 OSRAM	3"	11W	26°	2700K	4052899421233	4052899421240
LDTH DL 311 L38 827 9X1 OSRAM	3"	11W	38°	2700K	4052899421486	4052899421493
LDTH DL 311 L26 830 9X1 OSRAM	3"	11W	26°	3000K	4052899421509	4052899421516
LDTH DL 311 L38 830 9X1 OSRAM	3"	11W	38°	3000K	4052899421523	4052899421530
LDTH DL 311 L26 840 9X1 OSRAM	3"	11W	26°	4000K	4052899421547	4052899421554
LDTH DL 311 L38 840 9X1 OSRAM	3"	11W	38°	4000K	4052899421561	4052899421578
LDTH DL 411 L28 827 9X1 OSRAM	4"	11W	28°	2700K	4052899421585	4052899421592
LDTH DL 411 L40 827 9X1 OSRAM	4"	11W	40°	2700K	4052899421608	4052899421615
LDTH DL 411 L28 830 9X1 OSRAM	4"	11W	28°	3000K	4052899421622	4052899421639
LDTH DL 411 L40 830 9X1 OSRAM	4"	11W	40°	3000K	4052899421646	4052899421653
LDTH DL 411 L28 840 9X1 OSRAM	4"	11W	28°	4000K	4052899421660	4052899421677
LDTH DL 411 L40 840 9X1 OSRAM	4"	11W	40°	4000K	4052899421684	4052899421691
LDTH DL 415 L28 827 9X1 OSRAM	4"	15W	28°	2700K	4052899421707	4052899421714
LDTH DL 415 L40 827 9X1 OSRAM	4"	15W	40°	2700K	4052899421721	4052899421738
LDTH DL 415 L28 830 9X1 OSRAM	4"	15W	28°	3000K	4052899421745	4052899421752
LDTH DL 415 L40 830 9X1 OSRAM	4"	15W	40°	3000K	4052899421769	4052899421776
LDTH DL 415 L28 840 9X1 OSRAM	4"	15W	28°	4000K	4052899421783	4052899421790
LDTH DL 415 L40 840 9X1 OSRAM	4"	15W	40°	4000K	4052899421806	4052899421813
LDTH DL 520 L26 827 6X1 OSRAM	5"	20W	26°	2700K	4052899421820	4052899421837
LDTH DL 520 L38 827 6X1 OSRAM	5"	20W	38°	2700K	4052899421844	4052899421851
LDTH DL 520 L46 827 6X1 OSRAM	5"	20W	46°	2700K	4052899421868	4052899421875
LDTH DL 520 L26 830 6X1 OSRAM	5"	20W	26°	3000K	4052899421882	4052899421899
LDTH DL 520 L38 830 6X1 OSRAM	5"	20W	38°	3000K	4052899421905	4052899421912
LDTH DL 520 L46 830 6X1 OSRAM	5"	20W	46°	3000K	4052899421929	4052899421936
LDTH DL 520 L26 840 6X1 OSRAM	5"	20W	26°	4000K	4052899421943	4052899421950
LDTH DL 520 L38 840 6X1 OSRAM	5"	20W	38°	4000K	4052899423091	4052899423107
LDTH DL 520 L46 840 6X1 OSRAM	5"	20W	46°	4000K	4052899423114	4052899423121
LDTH DL 620 L26 827 6X1 OSRAM	6"	20W	26°	2700K	4052899423138	4052899423145
LDTH DL 620 L38 827 6X1 OSRAM	6"	20W	38°	2700K	4052899423152	4052899423169
LDTH DL 620 L46 827 6X1 OSRAM	6"	20W	46°	2700K	4052899423176	4052899423183
LDTH DL 620 L26 830 6X1 OSRAM	6"	20W	26°	3000K	4052899423190	4052899423206
LDTH DL 620 L38 830 6X1 OSRAM	6"	20W	38°	3000K	4052899423213	4052899423220
LDTH DL 620 L46 830 6X1 OSRAM	6"	20W	46°	3000K	4052899423237	4052899423244
LDTH DL 620 L26 840 6X1 OSRAM	6"	20W	26°	4000K	4052899423251	4052899423268
LDTH DL 620 L38 840 6X1 OSRAM	6"	20W	38°	4000K	4052899423275	4052899423282
LDTH DL 620 L46 840 6X1 OSRAM	6"	20W	46°	4000K	4052899423299	4052899423305

LEDTOUCH™ Downlight

Ordering Codes

Fixture

Short Text	Diameter	Power	Beam Angle	CCT	EAN10	EAN40
LDTH DL 628 L28 827 6X1 OSRAM	6"	28W	28°	2700K	4052899423312	4052899423329
LDTH DL 628 L40 827 6X1 OSRAM	6"	28W	40°	2700K	4052899423336	4052899423343
LDTH DL 628 L50 827 6X1 OSRAM	6"	28W	50°	2700K	4052899423350	4052899423367
LDTH DL 628 L28 830 6X1 OSRAM	6"	28W	28°	3000K	4052899423374	4052899423381
LDTH DL 628 L40 830 6X1 OSRAM	6"	28W	40°	3000K	4052899423398	4052899423404
LDTH DL 628 L50 830 6X1 OSRAM	6"	28W	50°	3000K	4052899423411	4052899423428
LDTH DL 628 L28 840 6X1 OSRAM	6"	28W	28°	4000K	4052899423459	4052899423466
LDTH DL 628 L40 840 6X1 OSRAM	6"	28W	40°	4000K	4052899423473	4052899423480
LDTH DL 628 L50 840 6X1 OSRAM	6"	28W	50°	4000K	4052899423497	4052899423503
LDTH DL 640 L28 827 6X1 OSRAM	6"	40W	28°	2700K	4052899423510	4052899423527
LDTH DL 640 L40 827 6X1 OSRAM	6"	40W	40°	2700K	4052899423534	4052899423541
LDTH DL 640 L50 827 6X1 OSRAM	6"	40W	50°	2700K	4052899423572	4052899423589
LDTH DL 640 L28 830 6X1 OSRAM	6"	40W	28°	3000K	4052899423596	4052899423602
LDTH DL 640 L40 830 6X1 OSRAM	6"	40W	40°	3000K	4052899423633	4052899423640
LDTH DL 640 L50 830 6X1 OSRAM	6"	40W	50°	3000K	4052899422346	4052899422353
LDTH DL 640 L28 840 6X1 OSRAM	6"	40W	28°	4000K	4052899422360	4052899422377
LDTH DL 640 L40 840 6X1 OSRAM	6"	40W	40°	4000K	4052899422537	4052899422544
LDTH DL 640 L50 840 6X1 OSRAM	6"	40W	50°	4000K	4052899422551	4052899422568
LDTH DL 840 L28 827 4X1 OSRAM	8"	40W	28°	2700K	4052899422582	4052899422599
LDTH DL 840 L38 827 4X1 OSRAM	8"	40W	38°	2700K	4052899422605	4052899422612
LDTH DL 840 L55 827 4X1 OSRAM	8"	40W	55°	2700K	4052899422629	4052899422636
LDTH DL 840 L28 830 4X1 OSRAM	8"	40W	28°	3000K	4052899422643	4052899422650
LDTH DL 840 L38 830 4X1 OSRAM	8"	40W	38°	3000K	4052899422667	4052899422674
LDTH DL 840 L55 830 4X1 OSRAM	8"	40W	55°	3000K	4052899422681	4052899422698
LDTH DL 840 L28 840 4X1 OSRAM	8"	40W	28°	4000K	4052899422704	4052899422711
LDTH DL 840 L38 840 4X1 OSRAM	8"	40W	38°	4000K	4052899422735	4052899422742
LDTH DL 840 L55 840 4X1 OSRAM	8"	40W	55°	4000K	4052899422759	4052899422766
LDTH DL 860 L28 827 4X1 OSRAM	8"	60W	28°	2700K	4052899422780	4052899422797
LDTH DL 860 L38 827 4X1 OSRAM	8"	60W	38°	2700K	4052899422803	4052899422810
LDTH DL 860 L55 827 4X1 OSRAM	8"	60W	55°	2700K	4052899422841	4052899422858
LDTH DL 860 L28 830 4X1 OSRAM	8"	60W	28°	3000K	4052899422865	4052899422872
LDTH DL 860 L38 830 4X1 OSRAM	8"	60W	38°	3000K	4052899422889	4052899422896
LDTH DL 860 L55 830 4X1 OSRAM	8"	60W	55°	3000K	4052899422902	4052899422919
LDTH DL 860 L28 840 4X1 OSRAM	8"	60W	28°	4000K	4052899422926	4052899422933
LDTH DL 860 L38 840 4X1 OSRAM	8"	60W	38°	4000K	4052899422940	4052899422957
LDTH DL 860 L55 840 4X1 OSRAM	8"	60W	55°	4000K	4052899422964	4052899422971